

A1, X1, Y1 B2

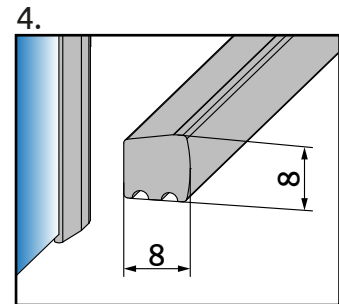
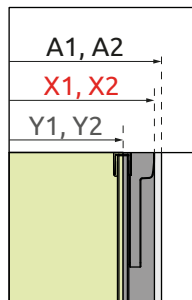
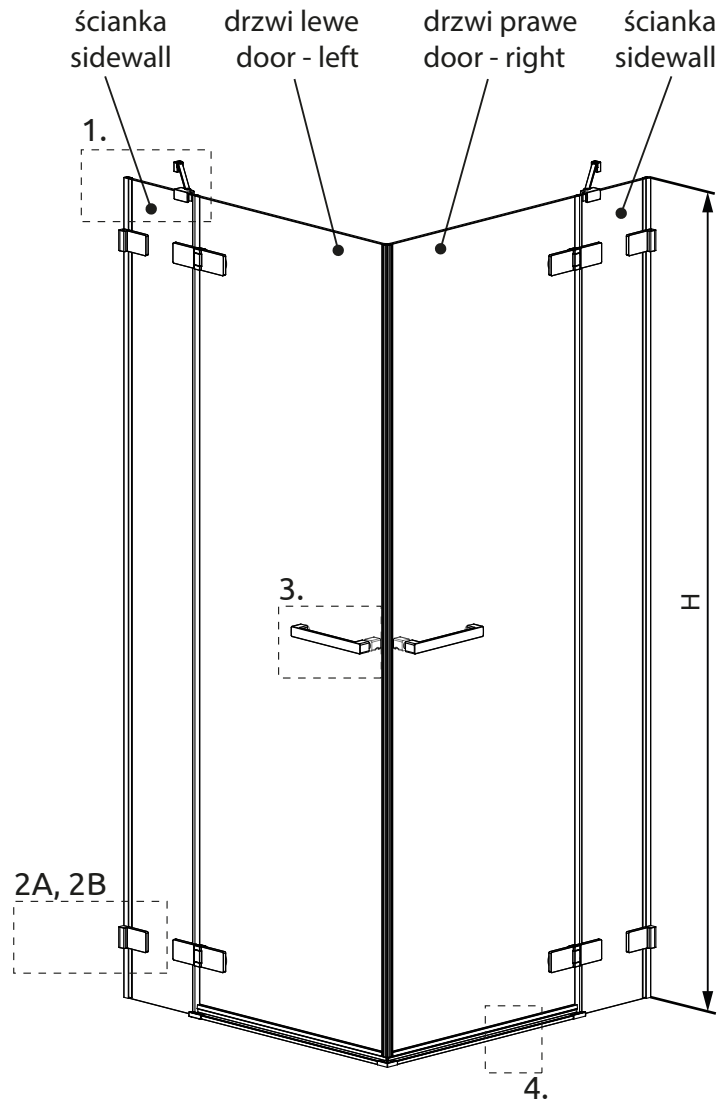
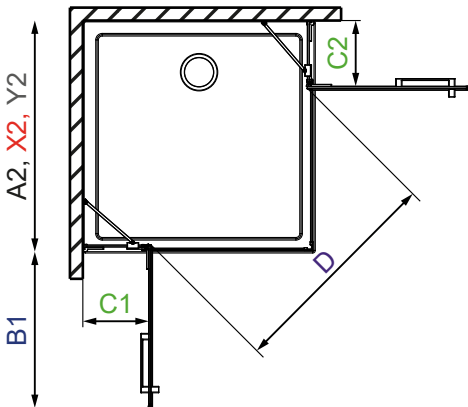

Model	A1	A2	X1	X2	Y1	Y2	B1	B2	C1	C2	D	H
KDD II 80Lx80R	800	800	795-805	795-805	773-783	773-783	520	520	256-266	256-266	715	2000
KDD II 80Lx90R	800	900	795-805	895-905	773-783	873-883	520	620	256-266	256-266	790	2000
KDD II 80Lx100R	800	1000	795-805	995-1005	773-783	973-983	520	620	256-266	356-366	790	2000
KDD II 90Lx80R	900	800	895-905	795-805	873-883	773-783	620	520	256-266	256-266	790	2000
KDD II 90Lx90R	900	900	895-905	895-905	873-883	873-883	620	620	256-266	256-266	855	2000
KDD II 90Lx100R	900	1000	895-905	995-1005	873-883	973-983	620	620	256-266	356-366	855	2000
KDD II 100Lx80R	1000	800	995-1005	795-805	973-983	773-783	620	520	356-366	256-266	790	2000
KDD II 100Lx90R	1000	900	995-1005	895-905	973-983	873-883	620	620	356-366	256-266	855	2000
KDD II 100Lx100R	1000	1000	995-1005	995-1005	973-983	973-983	620	620	356-366	356-366	855	2000